

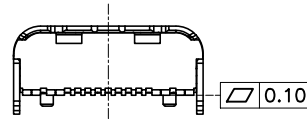

REV	DESCRIPTION	DATE	APPROVED
A	新版发行	2022.07.16	HHM

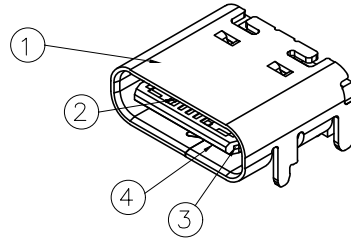

- ELECTRICAL:
CURRENT:15A
CONTACT RESISTANCE:40 MILLIOHMS MAX
DIELECTRIC WITHSTANDING VOLTAGE: 200V AC
INSULATION RESISTANCE:100 MEGOHMS MIN
- MECHANICAL:
MATING FORCE:6-20N
WITHDRAWAL FORCE:5-20N
DURBILITY:10000 CYCLES
- ENVIRONMENTAL:
TEMPERTURE RANGE -40℃~105℃
SALT TESTING:48 HOURS

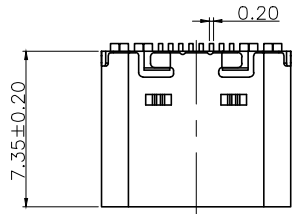
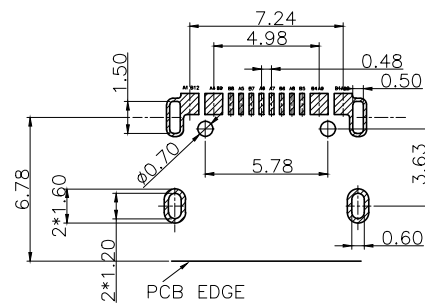
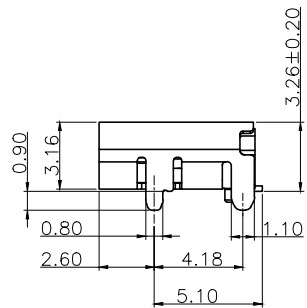
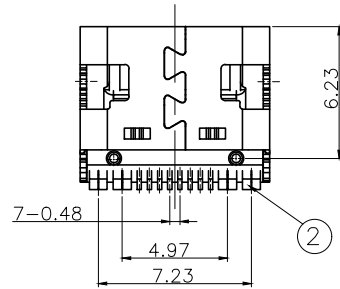
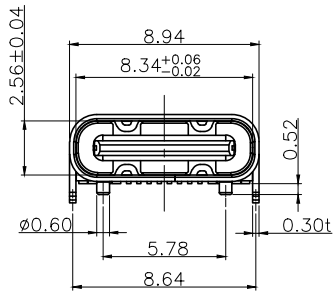

RECOMMENDED P. C. B. LAYOUT
TOLERANCE UNSPECIFIED ±0.05mm

7				
6				
5				
4	TYPE C MD	HIGH TEMP	BLACK	UL 94V-0
3	CENTER PIECE	STAINLESS STEEL	—	NO Plated
2	TYPE C TERMINAL	COPPER ALLOY	—	Gold Plated
1	SHELL	COPPER ALLOY	—	Ni Plated
NO.	DESCRIPTION	MATERIAL	COLOR	REMARK

CUSTOMER DRAWING			铭创科技（东莞）有限公司 Mingchuang Technology (Dongguan) Co., Ltd.	
UNITS mm	SCALE 1:1	SHEET 1 OF 1	TITLE TYPE C母座16PIN 15A大电流 板上四脚插板SMT L=7.35	
PROJECTION: 	DRAW: DAP	CHECK: HWT	MAT'L SEE TABLE	FINISH SEE TABLE
GENERAL TOLERANCE 0. ±0.50 0.0 ±0.30 0.00 ±0.15 0.° ±2° 0.0° ±1°	APPD: HHM	DWG. NO. 0208.TCF.16BS.H5	PART NO. _____	SIZE A4